

Item no. DD091-0825B9040

Series Name: Φ80 Series Lens Type

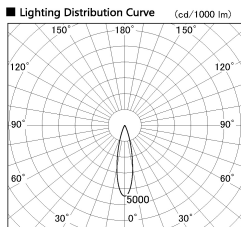

■ Direct Horizontal Illuminance DD091-0825B9040

Beam Angle	Vertical Illuminance (lx)
23°	10110
24°	2530
1	1120
2	630
3	400
4	280
5	210
6	160

Installation Type	Recessed mount
Fixture wattage	7.4W
Beam angle	30 deg
Color Temp.	4000K
CRI	Ra>90
Luminous	564 lm
Body	Die-cast aluminum alloy
Body finish	N/A
Trim finish	Black
Reflector finish	N/A
IP Rate	IP20
Light source	COB module
Input Voltage	AC220~240V
Dimming Type	Non-Dimmable
Certificate	CE, CCC
Cut Hole	80mm

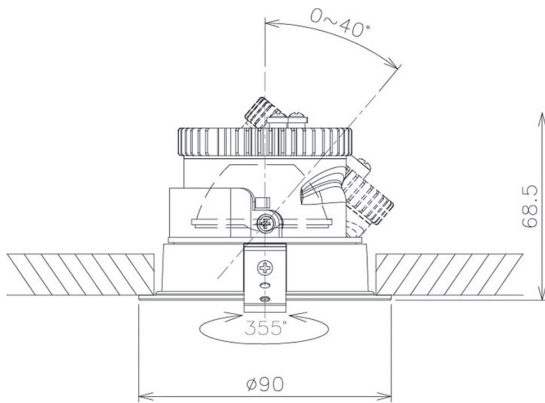

Height (Weight)	
36.0W	138 (0.7kg)
28.5W	138 (0.7kg)
21.0W	98 (0.6kg)
14.2W	98 (0.6kg)
7.4W	78 (0.6kg)
5.0W	78 (0.4kg)

