

Item no. DD091-1430B9035

Series Name: Φ 80 Series Lens Type

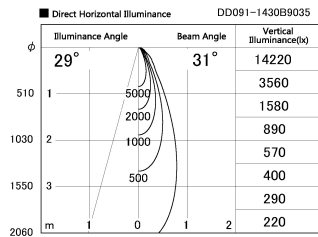

Installation Type	Recessed mount
Fixture wattage	14.2W
Beam angle	30 deg
Color Temp.	3500K
CRI	Ra>90
Luminous	1176 lm
Body	Die-cast aluminum alloy
Body finish	N/A
Trim finish	Black
Reflector finish	N/A
IP Rate	IP20
Light source	COB module
Input Voltage	AC220~240V
Dimming Type	Non-Dimmable
Certificate	CE, CCC
Cut Hole	80mm

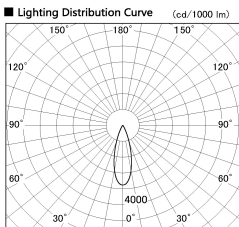
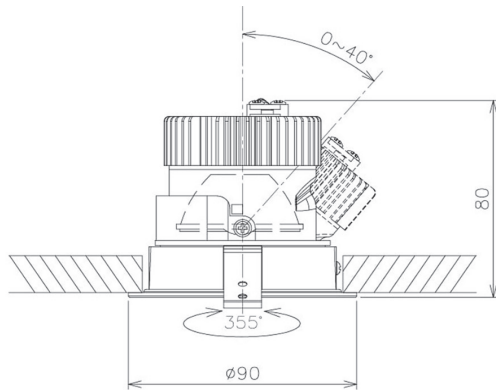

Height (Weight)	
36.0W	138 (0.7kg)
28.5W	138 (0.7kg)
21.0W	98 (0.6kg)
14.2W	98 (0.6kg)
7.4W	78 (0.6kg)
5.0W	78 (0.4kg)

