

Item no. DD098-5020DW9040

Series Name: Φ 150 Spark

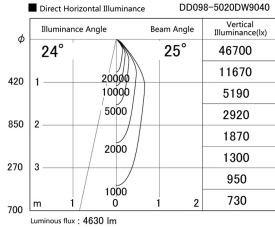

Dark Mirror Reflector

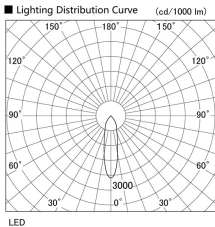

Installation	Recessed mount
Type	Φ 150 Spark
Fixture wattage	48.5W
Beam angle	25 deg
Color Temp.	4000K
CRI	Ra>90
Luminous	4629 lm
Body	Die-cast aluminum alloy
Body finish	N/A
Trim finish	White
Reflector finish	Dark Mirror
IP Rate	IP20
Light source	COB module
Input Voltage	AC220~240V
Dimming Type	Non-Dimmable
Certificate	CE, CCC
Cut Hole	150mm

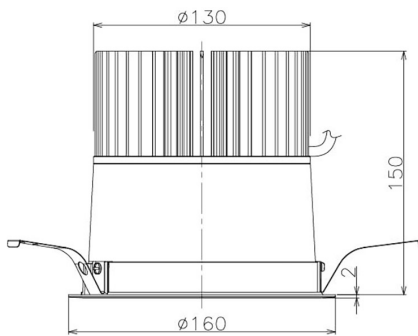

Height (Weight)	
65.3W	152 (1.5kg)
48.5W	152 (1.5kg)
44.3W	132 (1.3kg)
33.8W	132 (1.3kg)
30.3W	132 (1.3kg)
23.0W	102 (1.0kg)

