

Item no. DD098-3020MB8540

Series Name:  $\Phi$ 150 Spark

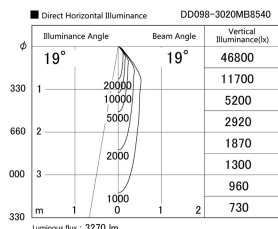

|                  |                         |
|------------------|-------------------------|
| Installation     | Recessed mount          |
| Type             |                         |
| Fixture wattage  | 30.3W                   |
| Beam angle       | 19 deg                  |
| Color Temp.      | 4000K                   |
| CRI              | Ra>85                   |
| Luminous         | 3271 lm                 |
| Body             | Die-cast aluminum alloy |
| Body finish      | N/A                     |
| Trim finish      | Black                   |
| Reflector finish | Mirror                  |
| IP Rate          | IP20                    |
| Light source     | COB module              |
| Input Voltage    | AC220~240V              |
| Dimming Type     | Non-Dimmable            |
| Certificate      | CE, CCC                 |
| Cut Hole         | 150mm                   |

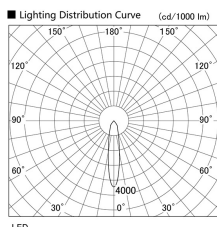
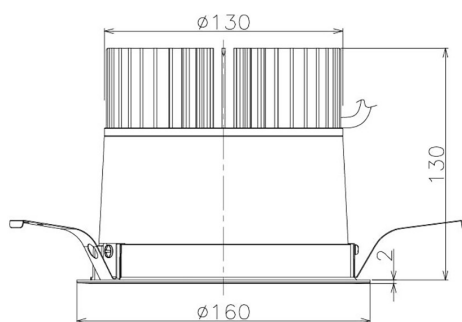

| Height (Weight) |             |
|-----------------|-------------|
| 65.3W           | 152 (1.5kg) |
| 48.5W           | 152 (1.5kg) |
| 44.3W           | 132 (1.3kg) |
| 33.8W           | 132 (1.3kg) |
| 30.3W           | 132 (1.3kg) |
| 23.0W           | 102 (1.0kg) |

