

Item no. DD098-3060MB9035

Series Name:  $\Phi$ 150 Spark

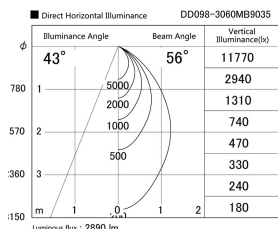

Installation	Recessed mount
Type	$\Phi$ 150 Spark
Fixture wattage	30.3W
Beam angle	42 deg
Color Temp.	3500K
CRI	Ra>90
Luminous	2892 lm
Body	Die-cast aluminum alloy
Body finish	N/A
Trim finish	Black
Reflector finish	Mirror
IP Rate	IP20
Light source	COB module
Input Voltage	AC220~240V
Dimming Type	Non-Dimmable
Certificate	CE, CCC
Cut Hole	150mm

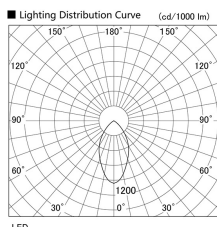
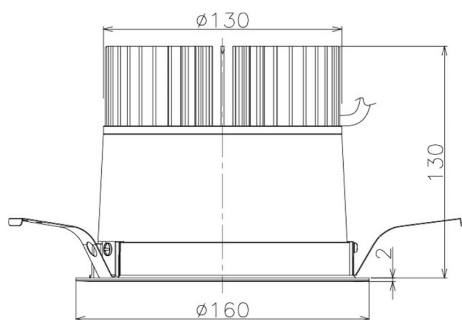

Height (Weight)	
65.3W	152 (1.5kg)
48.5W	152 (1.5kg)
44.3W	132 (1.3kg)
33.8W	132 (1.3kg)
30.3W	132 (1.3kg)
23.0W	102 (1.0kg)

