

Item no. DD098-5040MW9035L

Series Name: Φ 150 Spark (Swallow Cone)

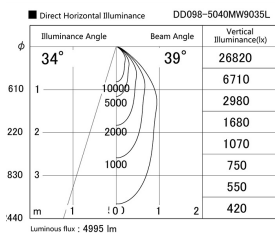

Installation	Recessed mount
Type	
Fixture wattage	48.5W
Beam angle	34 deg
Color Temp.	3500K
CRI	Ra>90
Luminous	4997 lm
Body	Die-cast aluminum alloy
Body finish	N/A
Trim finish	White
Reflector finish	Mirror
IP Rate	IP20
Light source	COB module
Input Voltage	AC220~240V
Dimming Type	Non-Dimmable
Certificate	CE, CCC
Cut Hole	150mm

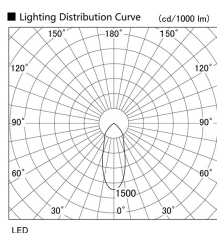
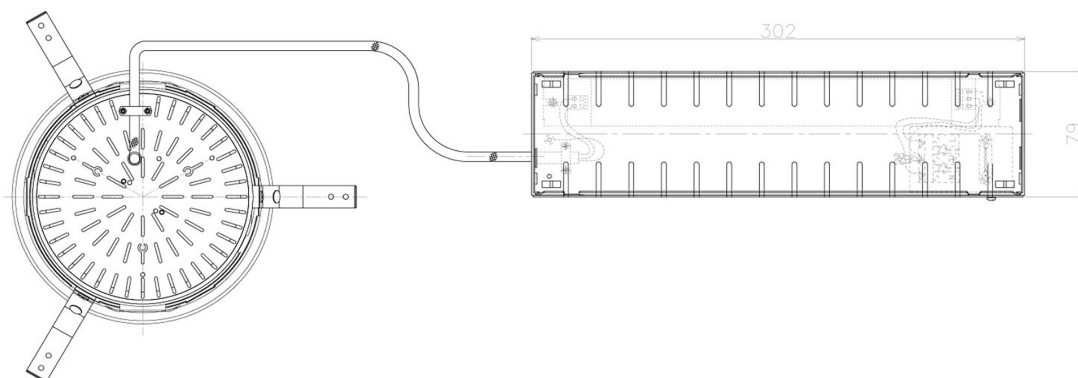
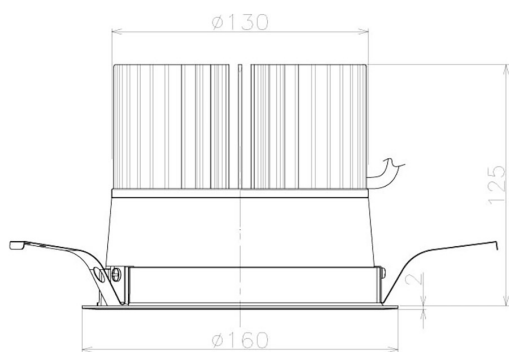

Height (Weight)	
65.3W	127 (1.4kg)
48.5W	127 (1.4kg)
44.3W	108 (1.2kg)
33.8W	108 (1.2kg)
30.3W	108 (1.2kg)
23.0W	78 (0.9kg)