

Item no. DD091-0820MB9030

Series Name: Φ 80 Series Lens Type, Antiglare

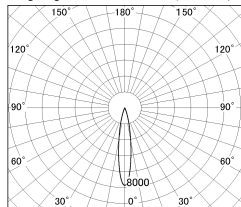

■ Lighting Distribution Curve (cd/1000 lm)



■ Direct Horizontal Illuminance DD091-0820MB9030

ϕ	Illuminance Angle	Beam Angle	Vertical Illuminance (lx)
	17°	17°	15930
1			3980
2			1770
3			1000
4			640
5			440
6			330
7			250

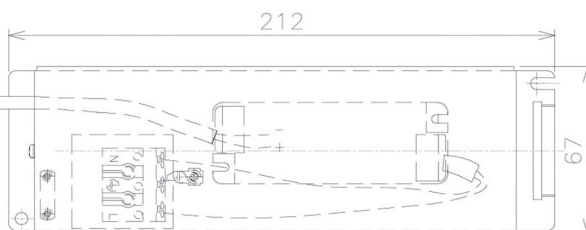
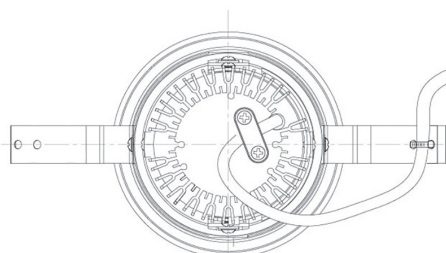
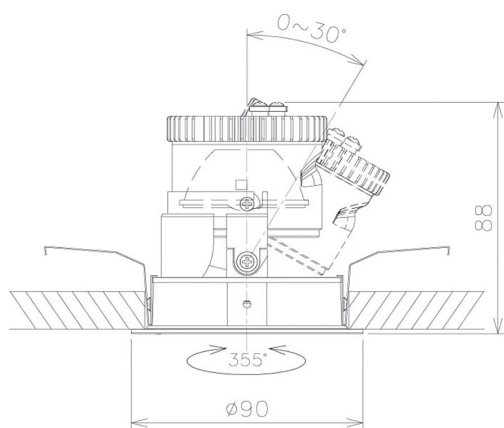

Installation	Recessed mount
Type	
Fixture wattage	7.4W
Beam angle	15 deg
Color Temp.	3000K
CRI	Ra>90
Luminous	509 lm
Body	Die-cast aluminum alloy
Body finish	N/A
Trim finish	Black
Reflector finish	Mirror
IP Rate	IP20
Light source	COB module
Input Voltage	AC220~240V
Dimming Type	Non-Dimmable
Certificate	CE, CCC
Cut Hole	80mm

Height (Weight)

36.0W	162 (0.7kg)
28.5W	162 (0.7kg)
21.0W	122 (0.6kg)
14.2W	122 (0.6kg)
7.4W	102 (0.6kg)
5.0W	102 (0.4kg)