

Item no. DD091-1420MB9035

Series Name: $\Phi 80$ Series Lens Type, Antiglare

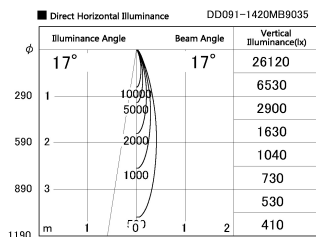

Installation	Recessed mount
Type	$\Phi 80$ Series Lens Type, Antiglare
Fixture wattage	14.2W
Beam angle	15 deg
Color Temp.	3500K
CRI	Ra>90
Luminous	835 lm
Body	Die-cast aluminum alloy
Body finish	N/A
Trim finish	Black
Reflector finish	Mirror
IP Rate	IP20
Light source	COB module
Input Voltage	AC220~240V
Dimming Type	Non-Dimmable
Certificate	CE, CCC
Cut Hole	80mm

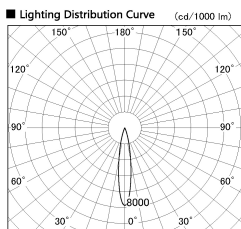
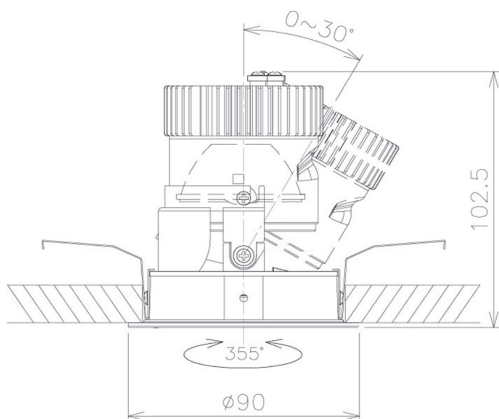

Height (Weight)	
36.0W	162 (0.7kg)
28.5W	162 (0.7kg)
21.0W	122 (0.6kg)
14.2W	122 (0.6kg)
7.4W	102 (0.6kg)
5.0W	102 (0.4kg)

