

Item no. DD091-1420MW9030

Series Name: $\Phi 80$ Series Lens Type, Antiglare

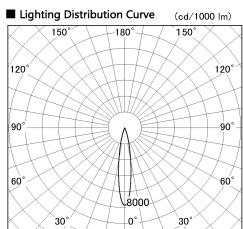

■ Direct Horizontal Illuminance DD091-1420MW9030

φ	Illuminance Angle	Beam Angle	Vertical Illuminance (lx)
	17°	17°	25590
1			6400
290	1		2840
			1600
500	2		1020
			710
890	3		520
			400
1190	m		

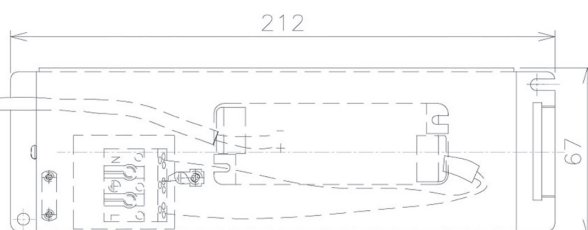
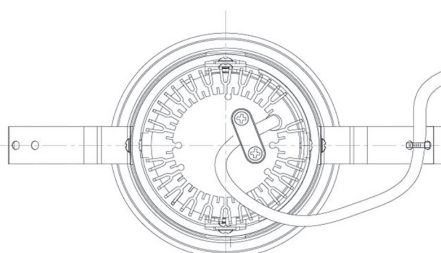
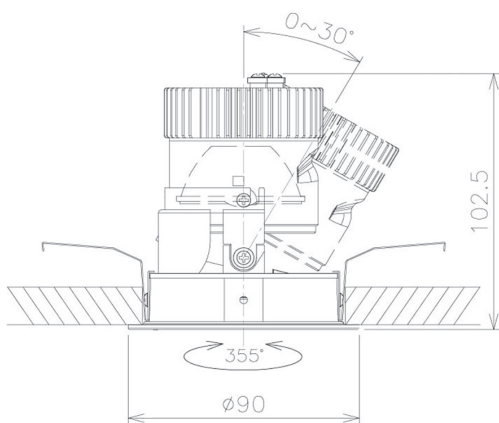

Installation	Recessed mount
Type	
Fixture wattage	14.2W
Beam angle	15 deg
Color Temp.	3000K
CRI	Ra>90
Luminous	818 lm
Body	Die-cast aluminum alloy
Body finish	N/A
Trim finish	White
Reflector finish	Mirror
IP Rate	IP20
Light source	COB module
Input Voltage	AC220~240V
Dimming Type	Non-Dimmable
Certificate	CE, CCC
Cut Hole	80mm

Height (Weight)	
36.0W	162 (0.7kg)
28.5W	162 (0.7kg)
21.0W	122 (0.6kg)
14.2W	122 (0.6kg)
7.4W	102 (0.6kg)
5.0W	102 (0.4kg)