

Item no. DD091-2125MW9027

Series Name: $\Phi 80$ Series Lens Type, Antiglare

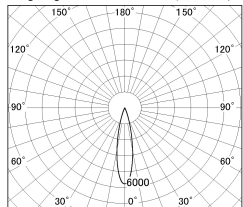

■ Lighting Distribution Curve (cd/1000 lm)



■ Direct Horizontal Illuminance DD091-2125MW9027

φ	Illuminance Angle	Beam Angle	Vertical Illuminance (lx)
370	21°	22°	23920
1			5980
740			2660
2			1500
1110			960
3			660
1480			490
m	1	0	370

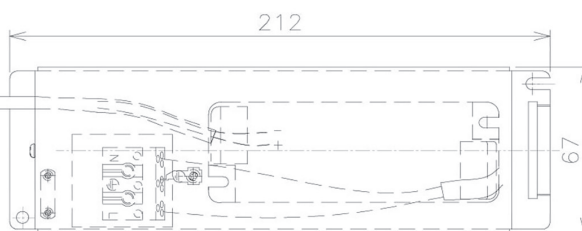
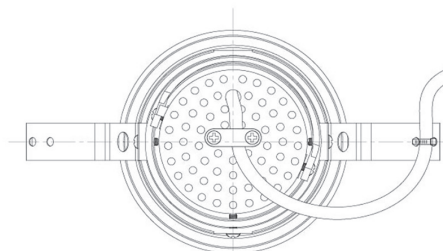
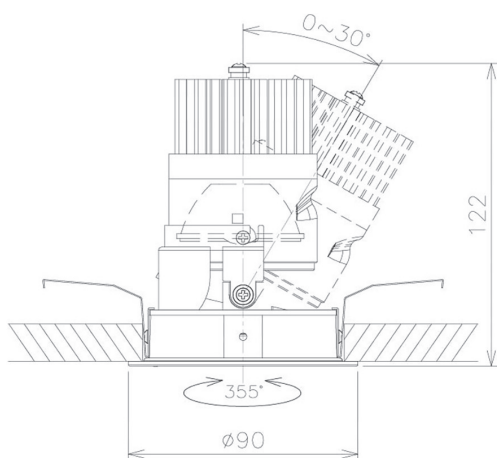

Installation	Recessed mount
Type	$\Phi 80$ Series Lens Type, Antiglare
Fixture wattage	21W
Beam angle	20 deg
Color Temp.	2700K
CRI	Ra>90
Luminous	1040 lm
Body	Die-cast aluminum alloy
Body finish	N/A
Trim finish	White
Reflector finish	Mirror
IP Rate	IP20
Light source	COB module
Input Voltage	AC220~240V
Dimming Type	Non-Dimmable
Certificate	CE, CCC
Cut Hole	80mm

Height (Weight)	
36.0W	162 (0.7kg)
28.5W	162 (0.7kg)
21.0W	122 (0.6kg)
14.2W	122 (0.6kg)
7.4W	102 (0.6kg)
5.0W	102 (0.4kg)