

Item no. DD068-3650DW8540D-AS

Series Name: Asymmetric

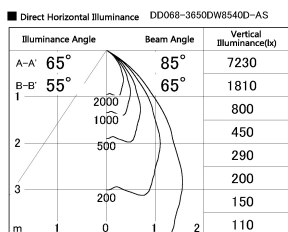

With Dark Mirror Reflector

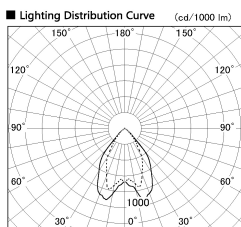

Installation	Recessed mount
Type	
Fixture wattage	36W
Beam angle	79 x 65 deg.
Color Temp.	4000K
CRI	Ra>85
Luminous	2690 lm
Body	Die-cast aluminum alloy
Body finish	N/A
Trim finish	White
Reflector finish	Dark Mirror
IP Rate	IP20
Light source	COB module
Input Voltage	AC220~240V
Dimming Type	Non-Dimmable
Certificate	CE, CCC
Cut Hole	150mm

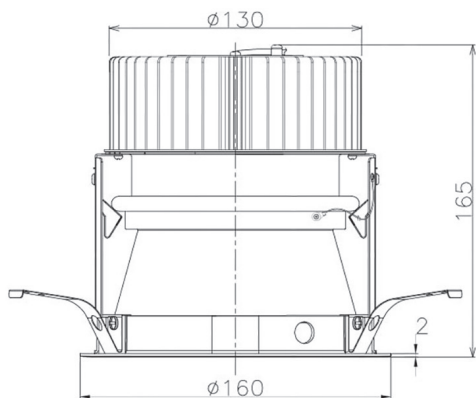

Height (Weight)	Wide flood
78.7W	177 (1.4kg)
58.5W	177 (1.4kg)
55.0W	177 (1.4kg)
42.8W	157 (1.1kg)
36.0W	157 (1.1kg)

