

Item no. DD068-3650WW8040D-AS

Series Name: Asymmetric

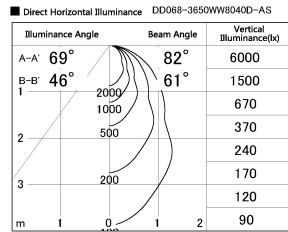

| | |
|------------------|-------------------------|
| Installation | Recessed mount |
| Type | Asymmetric |
| Fixture wattage | 36W |
| Beam angle | 79 x 65 deg. |
| Color Temp. | 4000K |
| CRI | Ra>80 |
| Luminous | 2690 lm |
| Body | Die-cast aluminum alloy |
| Body finish | N/A |
| Trim finish | White |
| Reflector finish | White |
| IP Rate | IP20 |
| Light source | COB module |
| Input Voltage | AC220~240V |
| Dimming Type | Non-Dimmable |
| Certificate | CE, CCC |
| Cut Hole | 150mm |

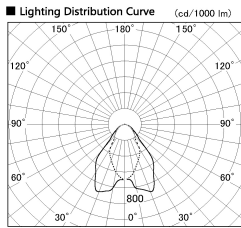
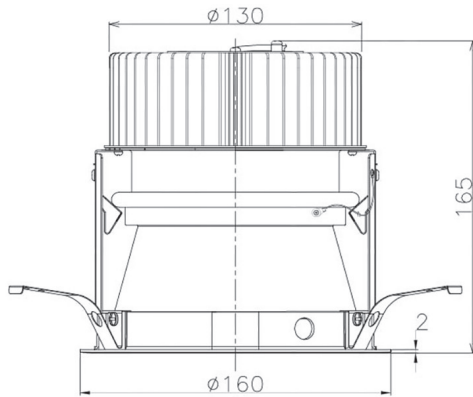

| Height (Weight) | Wide flood |
|-----------------|-------------|
| 78.7W | 177 (1.4kg) |
| 58.5W | 177 (1.4kg) |
| 55.0W | 177 (1.4kg) |
| 42.8W | 157 (1.1kg) |
| 36.0W | 157 (1.1kg) |

