

Item no. DD068-4250MW8540D-AS

Series Name: Asymmetric

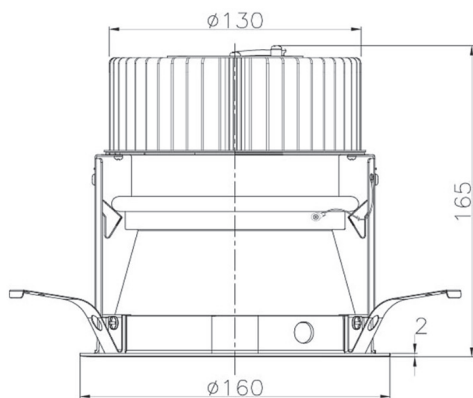

|                  |                         |
|------------------|-------------------------|
| Installation     | Recessed mount          |
| Type             |                         |
| Fixture wattage  | 42.8W                   |
| Beam angle       | 80 x 64 deg.            |
| Color Temp.      | 4000K                   |
| CRI              | Ra>85                   |
| Luminous         | 3344 lm                 |
| Body             | Die-cast aluminum alloy |
| Body finish      | N/A                     |
| Trim finish      | White                   |
| Reflector finish | Mirror                  |
| IP Rate          | IP20                    |
| Light source     | COB module              |
| Input Voltage    | AC220~240V              |
| Dimming Type     | Non-Dimmable            |
| Certificate      | CE, CCC                 |
| Cut Hole         | 150mm                   |

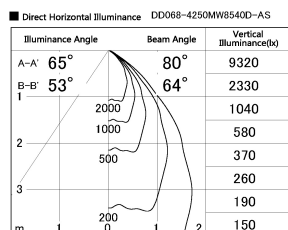
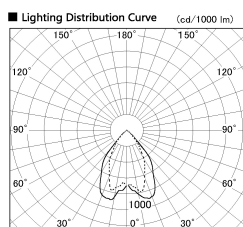

| Height (Weight) | Wide flood  |
|-----------------|-------------|
| 78.7W           | 177 (1.4kg) |
| 58.5W           | 177 (1.4kg) |
| 55.0W           | 177 (1.4kg) |
| 42.8W           | 157 (1.1kg) |
| 36.0W           | 157 (1.1kg) |

