

Item no. DD068-4250WW9040D-AS

Series Name: Asymmetric

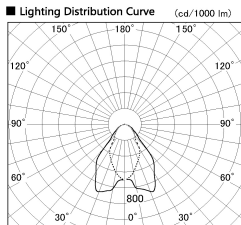

■ Direct Horizontal Illuminance DD068-4250WW9040D-AS

Illuminance Angle	Beam Angle	Vertical Illuminance (lx)
A-A' 69°	81°	5840
B-B' 46°	60°	1460
1	2000	650
2	1000	370
3	500	230
	200	160
	100	120
m	1	0
	1	2
		90

Installation	Recessed mount
Type	
Fixture wattage	42.8W
Beam angle	80 x 64 deg.
Color Temp.	4000K
CRI	Ra>90
Luminous	2611 lm
Body	Die-cast aluminum alloy
Body finish	N/A
Trim finish	White
Reflector finish	White
IP Rate	IP20
Light source	COB module
Input Voltage	AC220~240V
Dimming Type	Non-Dimmable
Certificate	CE, CCC
Cut Hole	150mm

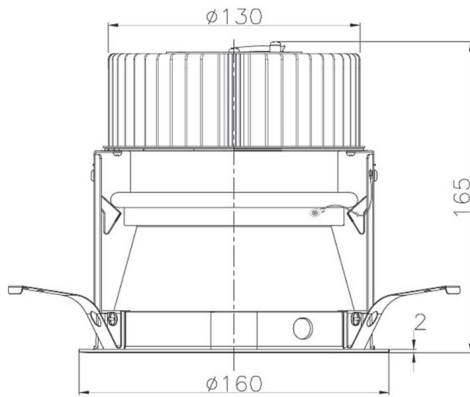

Height (Weight)	Wide flood
78.7W	177 (1.4kg)
58.5W	177 (1.4kg)
55.0W	177 (1.4kg)
42.8W	157 (1.1kg)
36.0W	157 (1.1kg)

