

Item no. DD068-5550WW9035D-AS

Series Name: Asymmetric

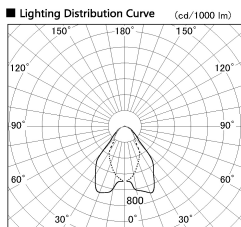

■ Direct Horizontal Illuminance DD068-5550WW9035D-AS

Illuminance Angle	Beam Angle	Vertical Illuminance (lx)
A-A' 70°	85°	7370
B-B' 45°	60°	1840
1		2000
		1000
2		500
3		200
		150
m	1 0 1 2	120

Installation	Recessed mount
Type	Asymmetric
Fixture wattage	55W
Beam angle	85 x 65 deg.
Color Temp.	3500K
CRI	Ra>90
Luminous	3309 lm
Body	Die-cast aluminum alloy
Body finish	N/A
Trim finish	White
Reflector finish	White
IP Rate	IP20
Light source	COB module
Input Voltage	AC220~240V
Dimming Type	Non-Dimmable
Certificate	CE, CCC
Cut Hole	150mm

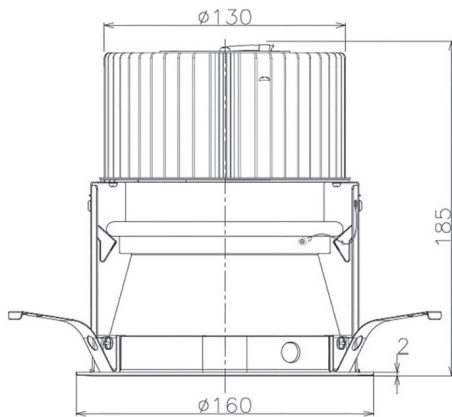

Height (Weight)	Wide flood
78.7W	177 (1.4kg)
58.5W	177 (1.4kg)
55.0W	177 (1.4kg)
42.8W	157 (1.1kg)
36.0W	157 (1.1kg)

