

Item no. DD068-8050DW9040D-AS

Series Name: Asymmetric

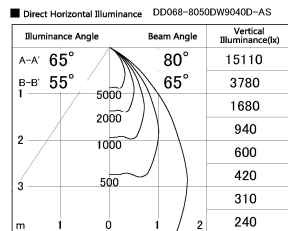

With Dark Mirror Reflector

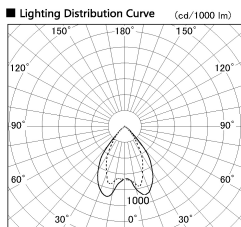

Installation	Recessed mount
Type	
Fixture wattage	78.7W
Beam angle	78 x 64 deg.
Color Temp.	4000K
CRI	Ra>90
Luminous	5654 lm
Body	Die-cast aluminum alloy
Body finish	N/A
Trim finish	White
Reflector finish	Dark Mirror
IP Rate	IP20
Light source	COB module
Input Voltage	AC220~240V
Dimming Type	Non-Dimmable
Certificate	CE, CCC
Cut Hole	150mm

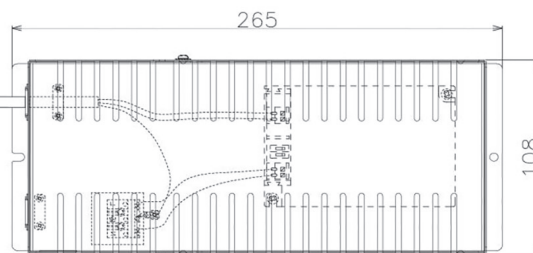
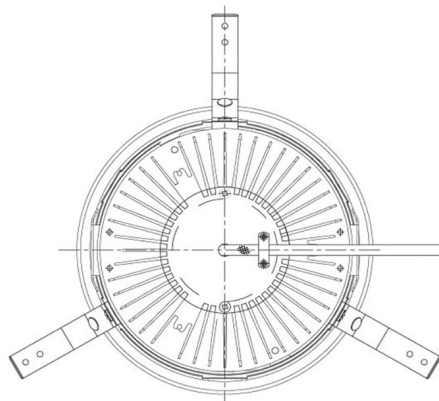
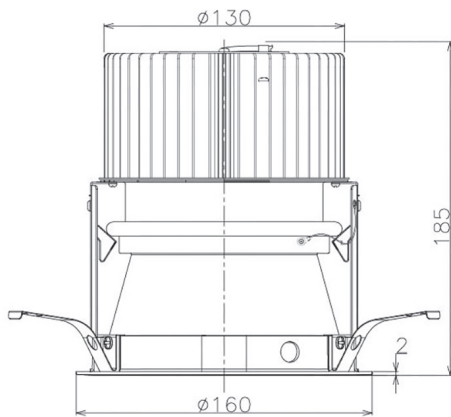

Height (Weight)	Wide flood
78.7W	177 (1.4kg)
58.5W	177 (1.4kg)
55.0W	177 (1.4kg)
42.8W	157 (1.1kg)
36.0W	157 (1.1kg)