

Item no. DD068-8050DB8535D-AS

Series Name: Asymmetric

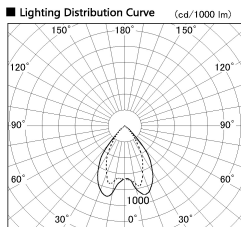

With Dark Mirror Reflector



■ Direct Horizontal Illuminance DD068-8050DB8535D-AS

Illuminance Angle	Beam Angle	Vertical Illuminance (lx)
A-A' 65°	80°	16450
B-B' 55°	65°	4110
1	5000	1830
2	1000	1030
3	500	660
		460
		340
m	1 0 1 2	260

Installation	Recessed mount
Type	Asymmetric
Fixture wattage	78.7W
Beam angle	78 x 64 deg.
Color Temp.	3500K
CRI	Ra>85
Luminous	6158 lm
Body	Die-cast aluminum alloy
Body finish	N/A
Trim finish	Black
Reflector finish	Dark Mirror
IP Rate	IP20
Light source	COB module
Input Voltage	AC220~240V
Dimming Type	Non-Dimmable
Certificate	CE, CCC
Cut Hole	150mm

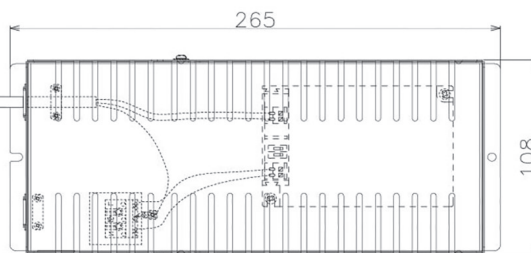
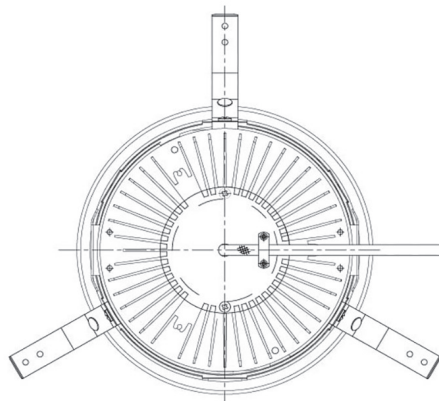
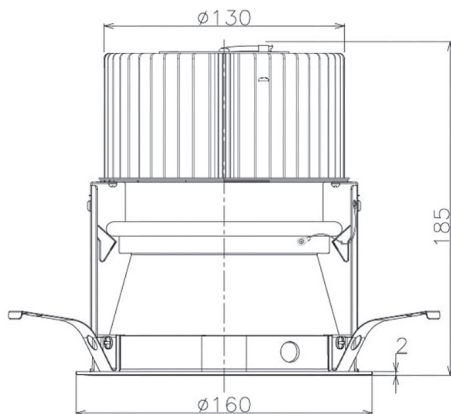

Height (Weight)	Wide flood
78.7W	177 (1.4kg)
58.5W	177 (1.4kg)
55.0W	177 (1.4kg)
42.8W	157 (1.1kg)
36.0W	157 (1.1kg)