

Item no. DD105-3220B9030

Series Name: Φ 100 Lens type Adjustable downlight

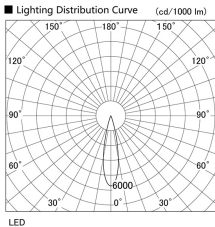

■ Direct Horizontal Illuminance DD105-3220B9030

Illuminance Angle	Beam Angle	Vertical Illuminance (lx)
22°	23°	62580
		15640
		6950
		3910
		2500
		1740
		1280
		980

Luminous flux : 2745 lm

Installation	Recessed mount
Type	
Fixture wattage	31.8W
Beam angle	23 deg
Color Temp.	3000K
CRI	Ra>90
Luminous	2746 lm
Body	Die-cast aluminum alloy
Body finish	N/A
Trim finish	Black
Reflector finish	N/A
IP Rate	IP20
Light source	COB module
Input Voltage	AC220~240V
Dimming Type	Non-Dimmable
Certificate	CE, CCC
Cut Hole	100mm

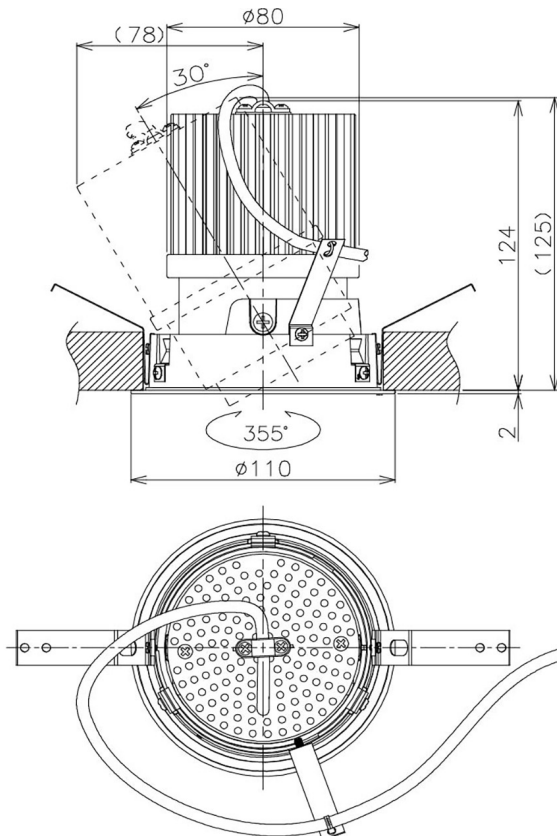

Height (Weight)	
31.8W	127 (0.9kg)
24.3W	127 (0.9kg)
21.0W	92 (0.8kg)
14.0W	92 (0.8kg)