

Item no. DD105-3220B9035

Series Name: Φ 100 Lens type Adjustable downlight

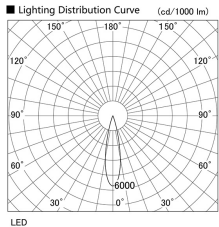

Illuminance Angle	Beam Angle	Vertical Illuminance(cd)
22°	23°	65700
		16430
		7300
		4110
		2630
		1830
		1340
		1030

Luminous flux : 2885 lm

Installation	Recessed mount
Type	
Fixture wattage	31.8W
Beam angle	23 deg
Color Temp.	3500K
CRI	Ra>90
Luminous	2883 lm
Body	Die-cast aluminum alloy
Body finish	N/A
Trim finish	Black
Reflector finish	N/A
IP Rate	IP20
Light source	COB module
Input Voltage	AC220~240V
Dimming Type	Non-Dimmable
Certificate	CE, CCC
Cut Hole	100mm

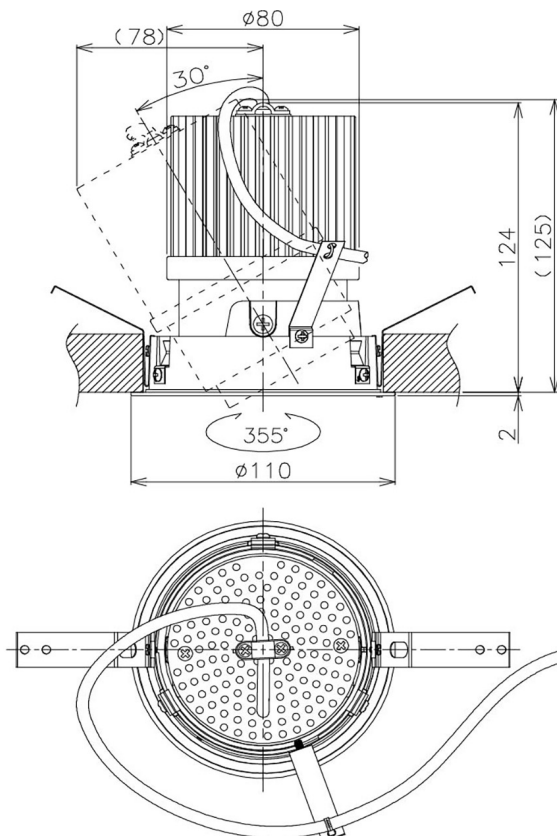

Height (Weight)	
31.8W	127 (0.9kg)
24.3W	127 (0.9kg)
21.0W	92 (0.8kg)
14.0W	92 (0.8kg)