

Item no. DD105-1450DB9030

Series Name: Φ 100 Lens type Adjustable downlight, Antiglare

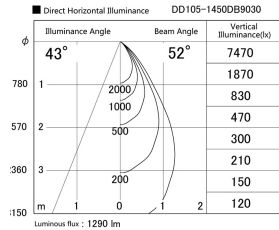

With Dark Mirror Reflector

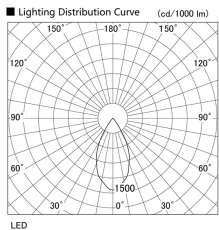

Installation	Recessed mount
Type	
Fixture wattage	14W
Beam angle	52 deg
Color Temp.	3000K
CRI	Ra>90
Luminous	1290 lm
Body	Die-cast aluminum alloy
Body finish	N/A
Trim finish	Black
Reflector finish	Dark Mirror
IP Rate	IP20
Light source	COB module
Input Voltage	AC220~240V
Dimming Type	Non-Dimmable
Certificate	CE, CCC
Cut Hole	100mm

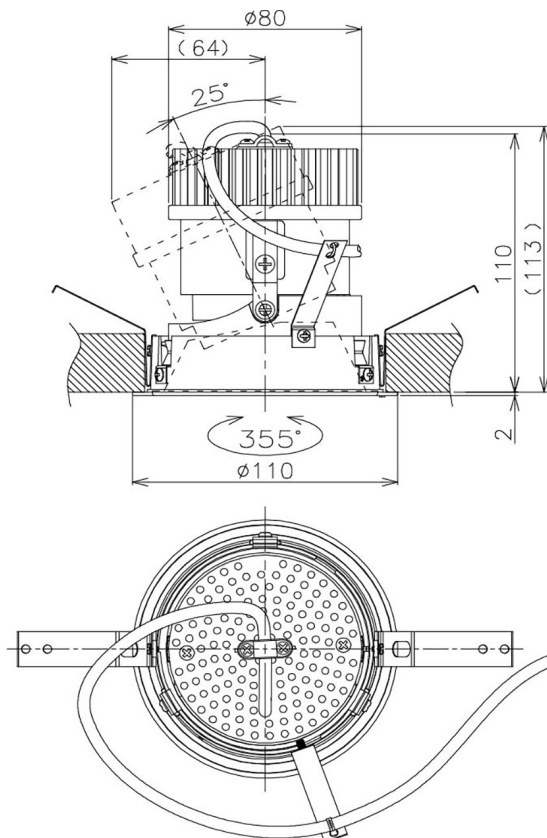

Height (Weight)	
31.8W	152 (0.9kg)
24.3W	152 (0.9kg)
21.0W	115 (0.8kg)
14.0W	115 (0.8kg)