

Item no. DD138-5040MW9030

Series Name: Φ 150 Spark (DD138)

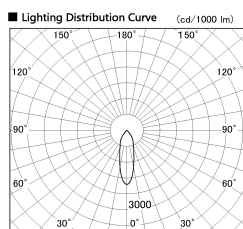

Installation	Recessed mount
Type	Φ 150 Spark (DD138)
Fixture wattage	48.5W
Beam angle	29deg
Color Temp.	3000K
CRI	Ra>90
Luminous	6377 lm
Body	Die-castaluminumalloy
Body finish	N/A
Trim finish	White
Reflector finish	Mirror
IP Rate	IP20
Light source	COB module
Input Voltage	AC220~240V
Dimming Type	Non-Dimmable
Certificate	CE,CCC
Cut Hole	150



Direct Horizontal Illuminance DD138-5040MW9030

Illuminance Angle	Beam Angle	Vertical Illuminance (lx)
26°	1	52340
	2	13080
29°	1	5820
	2	3270
3000	3	2090
	4	1450
1070	5	1070
	6	820

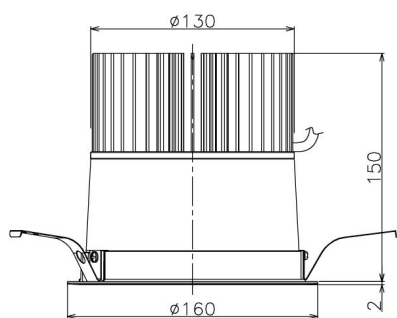

Height (Weight)	
48.5W	130 (1.3kg)
41.0W	130 (1.3kg)
28.0W	130 (1.3kg)
23.0W	100 (1.0kg)
20.0W	100 (1.0kg)

