

Item no. DD138-5020MW9035

Series Name: Φ 150 Spark (DD138)

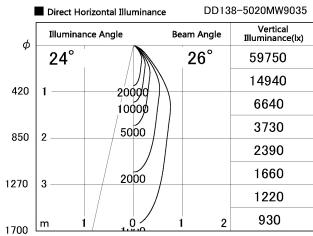

Installation	Recessed mount
Type	Φ 150 Spark (DD138)
Fixture wattage	48.5W
Beam angle	26deg
Color Temp.	3500K
CRI	Ra>90
Luminous	6332 lm
Body	Die-castaluminumalloy
Body finish	N/A
Trim finish	White
Reflector finish	Mirror
IP Rate	IP20
Light source	COB module
Input Voltage	AC220~240V
Dimming Type	Non-Dimmable
Certificate	CE,CCC
Cut Hole	150

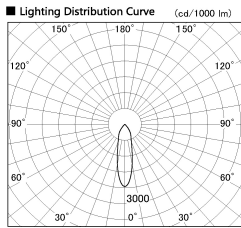
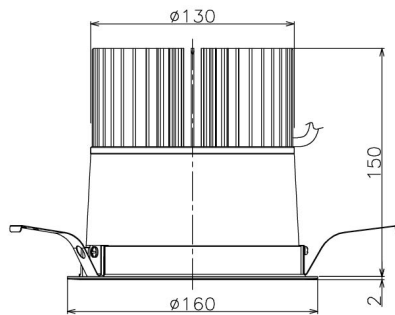

Height (Weight)	
48.5W	130 (1.3kg)
41.0W	130 (1.3kg)
28.0W	130 (1.3kg)
23.0W	100 (1.0kg)
20.0W	100 (1.0kg)

