

Item no. DD098-3415MB8527D

Series Name: Φ 150 Spark (Deep Cone)

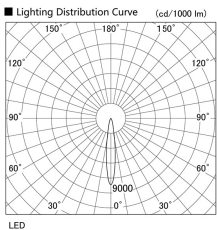

■ Direct Horizontal Illuminance DD098-3415MB8527D

Illuminance Angle	Beam Angle	Vertical Illuminance (lx)
ϕ 14°	1	99210
	2	24800
	3	11020
	4	6200
	5	3970
	6	2760
	7	2020
	8	1550

Luminous flux : 3080 lm

Installation	Recessed mount
Type	
Fixture wattage	33.8W
Beam angle	14 deg
Color Temp.	2700K
CRI	Ra>85
Luminous	3079 lm
Body	Die-cast aluminum alloy
Body finish	N/A
Trim finish	Black
Reflector finish	Mirror
IP Rate	IP20
Light source	COB module
Input Voltage	AC220~240V
Dimming Type	Non-Dimmable
Certificate	CE, CCC
Cut Hole	150mm

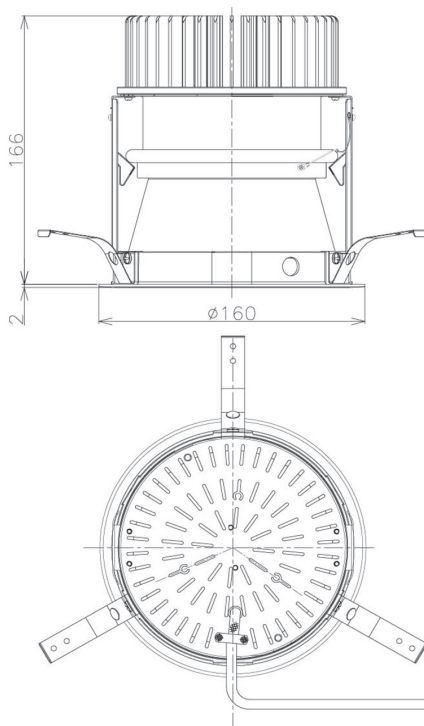

Height (Weight)	Spot / Medium / Medium flood	Wide flood
65.3W	177 (1.4kg)	
48.5W	177 (1.5kg)	
44.3W	157 (1.2kg)	
33.8W	168 (1.1kg)	157 (1.1kg)
30.3W	168 (1.1kg)	157 (1.1kg)
23.0W	138 (0.9kg)	127 (0.9kg)