

Item no. DD098-3420WW8527D

Series Name: Φ 150 Spark (Deep Cone)

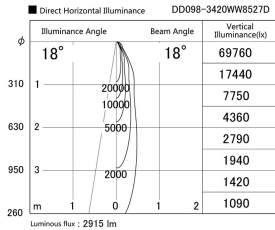

Dark Mirror Reflector

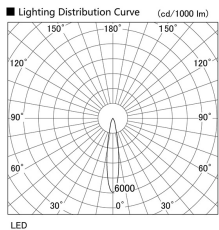

| | |
|------------------|-------------------------|
| Installation | Recessed mount |
| Type | |
| Fixture wattage | 33.8W |
| Beam angle | 18 deg |
| Color Temp. | 2700K |
| CRI | Ra>85 |
| Luminous | 2913 lm |
| Body | Die-cast aluminum alloy |
| Body finish | N/A |
| Trim finish | White |
| Reflector finish | Dark Mirror |
| IP Rate | IP20 |
| Light source | COB module |
| Input Voltage | AC220~240V |
| Dimming Type | Non-Dimmable |
| Certificate | CE, CCC |
| Cut Hole | 150mm |

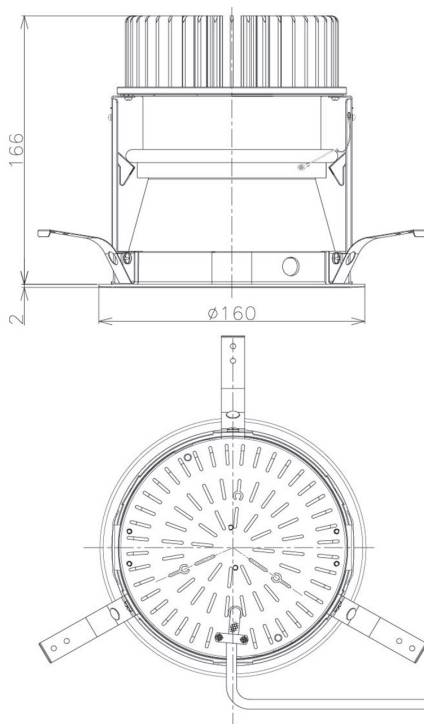

| Height (Weight) | Spot / Medium / Medium flood | Wide flood |
|-----------------|------------------------------|-------------|
| 65.3W | 177 (1.4kg) | |
| 48.5W | 177 (1.5kg) | |
| 44.3W | 157 (1.2kg) | |
| 33.8W | 168 (1.1kg) | 157 (1.1kg) |
| 30.3W | 168 (1.1kg) | 157 (1.1kg) |
| 23.0W | 138 (0.9kg) | 127 (0.9kg) |