

Item no. DD138-4520MW9030D

Series Name:  $\Phi$ 150 Spark (Deep Cone)  
(DD138D)

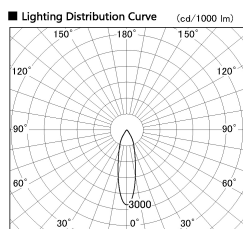

■ Direct Horizontal Illuminance DD138-4520MW9030D

Illuminance Angle	Beam Angle	Vertical Illuminance (lx)
24°	26°	52090
		13020
		5790
		3260
		2080
26°	26°	1450
		1060
		810

Installation	Recessed Mount
Type	$\Phi$ 150 Spark (Deep Cone) (DD138D)
Fixture wattage	41W
Beam angle	26 deg
Color Temp.	3000K
CRI	Ra>90
Luminous	4589 lm
Body	Die-cast aluminum alloy
Body finish	White
Trim finish	White
Reflector finish	Mirror
IP Rate	IP20
Light source	COB module
Input Voltage	AC220~240V
Dimming Type	Non-Dimmable
Certificate	CE,CCC
Cut Hole	150

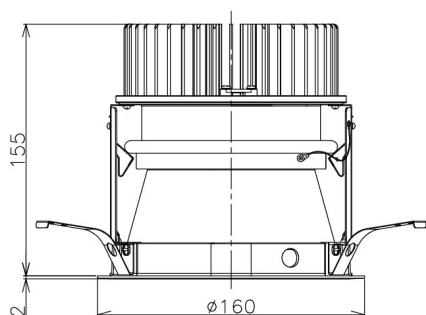

Height (Weight)	Spot / Medium / Medium flood	Wide flood
48.5W	175 (1.4kg)	
41.0W	155 (1.1kg)	
28.0W	166 (1.1kg)	155 (1.1kg)
23.0W	136 (0.9kg)	125 (0.9kg)
20.0W	136 (0.9kg)	125 (0.9kg)

