

Item no. DD138-5030MW9035D

Series Name:  $\Phi$ 150 Spark (Deep Cone)  
(DD138D)

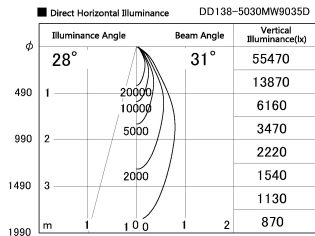

Installation	Recessed Mount
Type	$\Phi$ 150 Spark (Deep Cone) (DD138D)
Fixture wattage	48.5W
Beam angle	31 deg
Color Temp.	3500K
CRI	Ra>90
Luminous	6105 lm
Body	Die-cast aluminum alloy
Body finish	White
Trim finish	White
Reflector finish	Mirror
IP Rate	IP20
Light source	COB module
Input Voltage	AC220~240V
Dimming Type	Non-Dimmable
Certificate	CE,CCC
Cut Hole	150

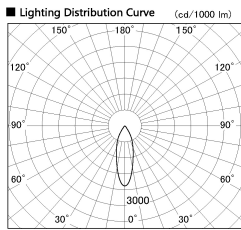
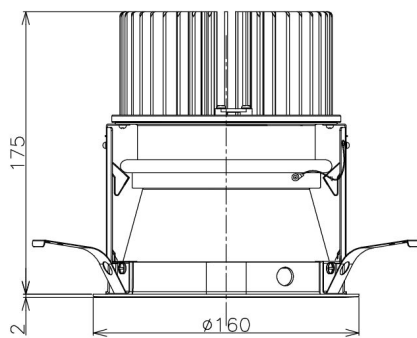

Height (Weight)	Spot / Medium / Medium flood	Wide flood
48.5W	175 (1.4kg)	
41.0W	155 (1.1kg)	
28.0W	166 (1.1kg)	155 (1.1kg)
23.0W	136 (0.9kg)	125 (0.9kg)
20.0W	136 (0.9kg)	125 (0.9kg)

