

Item no. DD138-4530MW9040D

Series Name: Φ 150 Spark (Deep Cone)
(DD138D)

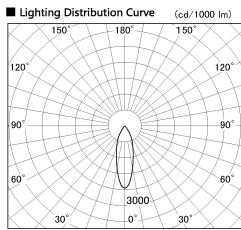

■ Direct Horizontal Illuminance DD138-4530MW9040D

Illuminance Angle	Beam Angle	Vertical Illuminance (lx)
27°	30°	43570
		10890
		4840
		2720
		1740
		1210
1920 m	1	890
		680
		680

Installation	Recessed Mount
Type	Φ 150 Spark (Deep Cone) (DD138D)
Fixture wattage	41W
Beam angle	30 deg
Color Temp.	4000K
CRI	Ra>90
Luminous	4628 lm
Body	Die-cast aluminum alloy
Body finish	White
Trim finish	White
Reflector finish	Mirror
IP Rate	IP20
Light source	COB module
Input Voltage	AC220~240V
Dimming Type	Non-Dimmable
Certificate	CE,CCC
Cut Hole	150

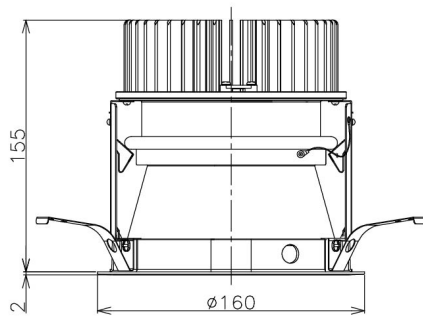

Height (Weight)	Spot / Medium / Medium flood	Wide flood
48.5W	175 (1.4kg)	
41.0W	155 (1.1kg)	
28.0W	166 (1.1kg)	155 (1.1kg)
23.0W	136 (0.9kg)	125 (0.9kg)
20.0W	136 (0.9kg)	125 (0.9kg)

