

Item no. DD138-4550MB9027D

Series Name: Φ 150 Spark (Deep Cone)
(DD138D)

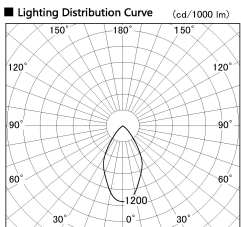

■ Direct Horizontal Illuminance DD138-4550MB9027D

Illuminance Angle	Beam Angle	Vertical Illuminance (lx)
44°	57°	20700
		5170
		2300
		1290
		830
		570
		420
		320

Installation	Recessed Mount
Type	Φ 150 Spark (Deep Cone) (DD138D)
Fixture wattage	41W
Beam angle	37 deg
Color Temp.	2700K
CRI	Ra>90
Luminous	4885 lm
Body	Die-cast aluminum alloy
Body finish	Black
Trim finish	Black
Reflector finish	Mirror
IP Rate	IP20
Light source	COB module
Input Voltage	AC220~240V
Dimming Type	Non-Dimmable
Certificate	CE,CCC
Cut Hole	150

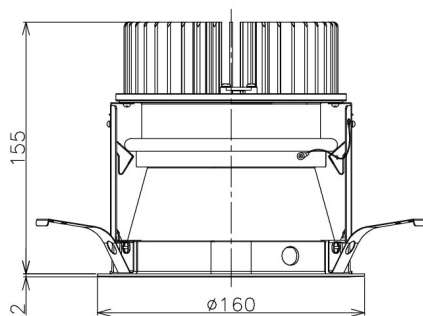

Height (Weight)	Spot / Medium / Medium flood	Wide flood
48.5W	175 (1.4kg)	
41.0W	155 (1.1kg)	
28.0W	166 (1.1kg)	155 (1.1kg)
23.0W	136 (0.9kg)	125 (0.9kg)
20.0W	136 (0.9kg)	125 (0.9kg)

