

Item no. DD138-5020MB9030D

Series Name:  $\Phi$ 150 Spark (Deep Cone)  
(DD138D)

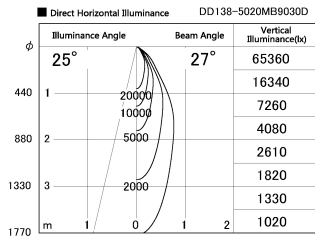

|                  |  |
|------------------|--|
| Installation     | Recessed Mount                           |
| Type             | $\Phi$ 150 Spark (Deep Cone)<br>(DD138D) |
| Fixture wattage  | 48.5W                                    |
| Beam angle       | 27 deg                                   |
| Color Temp.      | 3000K                                    |
| CRI              | Ra>90                                    |
| Luminous         | 6149 lm                                  |
| Body             | Die-cast aluminum alloy                  |
| Body finish      | Black                                    |
| Trim finish      | Black                                    |
| Reflector finish | Mirror                                   |
| IP Rate          | IP20                                     |
| Light source     | COB module                               |
| Input Voltage    | AC220~240V                               |
| Dimming Type     | Non-Dimmable                             |
| Certificate      | CE,CCC                                   |
| Cut Hole         | 150                                      |

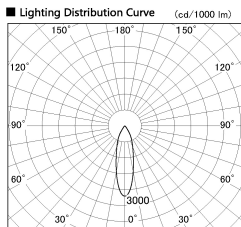
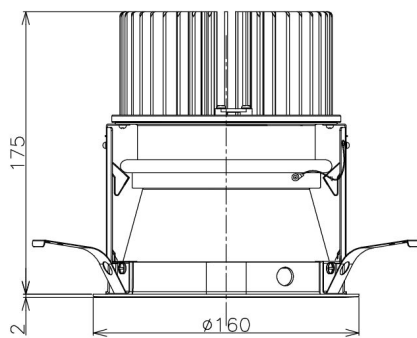

| Height (Weight) | Spot / Medium / Medium flood | Wide flood  |
|-----------------|------------------------------|-------------|
| 48.5W           | 175 (1.4kg)                  |             |
| 41.0W           | 155 (1.1kg)                  |             |
| 28.0W           | 166 (1.1kg)                  | 155 (1.1kg) |
| 23.0W           | 136 (0.9kg)                  | 125 (0.9kg) |
| 20.0W           | 136 (0.9kg)                  | 125 (0.9kg) |

