

Item no. DD138-5060MW9030

Series Name: Cledy spark (Normal cone)  
(DD138)

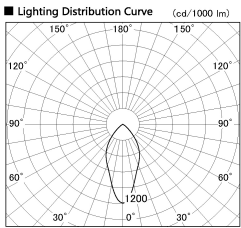

■ Direct Horizontal Illuminance DD138-5060MW9030

φ	Illuminance Angle	Beam Angle	Vertical Illuminance (lx)
630	35°	45°	32340
1260			8090
1890			3590
2520			2020
			1290
			900
			660
			510

Installation	Recessed mount	
Type	High-efficiency	Fixed
	downlight Φ150	
Fixture wattage	48.5W	
Beam angle	40deg	
Color Temp.	3000K	
CRI	Ra>90	
Luminous	6883 lm	
Body	Die-cast aluminum alloy	
Body finish	N/A	
Trim finish	White	
Reflector finish	Mirror	
IP Rate	IP20	
Light source	COB module	
Input Voltage	AC220~240V	
Dimming Type	Non-Dimmable	
Certificate	CE,CCC	
Cut Hole	150	

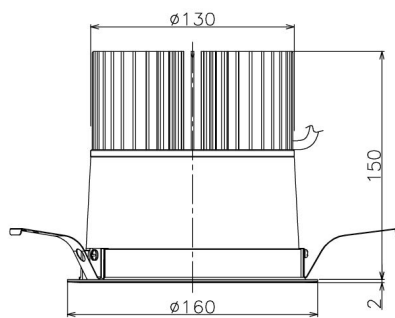

Height (Weight)	
48.5W	130 (1.3kg)
41.0W	130 (1.3kg)
28.0W	130 (1.3kg)
23.0W	100 (1.0kg)
20.0W	100 (1.0kg)

