

Item no. DD138-4550MW9040D

Series Name: Cledy spark (Deep cone)  
(DD138D)

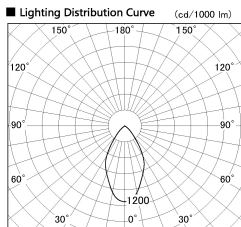

■ Direct Horizontal Illuminance DD138-4550MW9040D

Illuminance Angle	Beam Angle	Vertical Illuminance (lx)
45°	1	21200
	2	5300
	3	2360
	4	1330
	5	850
55°	1	590
	2	430
	3	330
	4	230
	5	180

Installation	Recessed Mount	
Type	High-efficiency downlight $\Phi$ 150	Fixed
Fixture wattage	41W	
Beam angle	37 deg	
Color Temp.	4000K	
CRI	Ra>90	
Luminous	5005 lm	
Body	Die-cast aluminum alloy	
Body finish	White	
Trim finish	White	
Reflector finish	Mirror	
IP Rate	IP20	
Light source	COB module	
Input Voltage	AC220~240V	
Dimming Type	Non-Dimmable	
Certificate	CE,CCC	
Cut Hole	150	

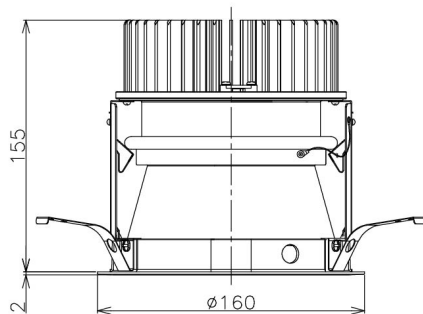

Height (Weight)	Spot / Medium / Medium flood	Wide flood
48.5W	175 (1.4kg)	
41.0W	155 (1.1kg)	
28.0W	166 (1.1kg)	155 (1.1kg)
23.0W	136 (0.9kg)	125 (0.9kg)
20.0W	136 (0.9kg)	125 (0.9kg)

