

Item no. DD138-4520MB9035D

Series Name: Cledy spark (Deep cone)  
(DD138D)

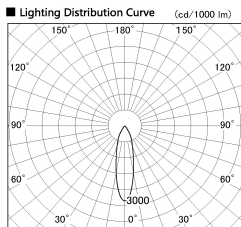

■ Direct Horizontal Illuminance DD138-4520MB9035D

Illuminance Angle	Beam Angle	Vertical Illuminance (lx)
24°	26°	51570
		12890
		5730
		3220
		2060
		1430
		1050
		810

Installation	Recessed Mount	
Type	High-efficiency downlight $\Phi$ 150	Fixed
Fixture wattage	41W	
Beam angle	26 deg	
Color Temp.	3500K	
CRI	Ra>90	
Luminous	4543 lm	
Body	Die-cast aluminum alloy	
Body finish	Black	
Trim finish	Black	
Reflector finish	Mirror	
IP Rate	IP20	
Light source	COB module	
Input Voltage	AC220~240V	
Dimming Type	Non-Dimmable	
Certificate	CE,CCC	
Cut Hole	150	

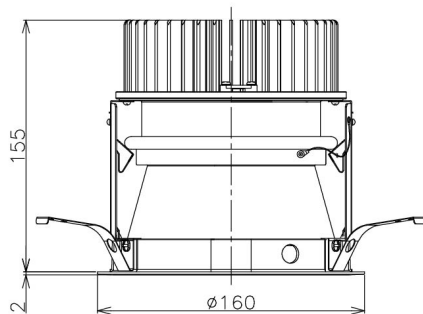

Height (Weight)	Spot / Medium / Medium flood	Wide flood
48.5W	175 (1.4kg)	
41.0W	155 (1.1kg)	
28.0W	166 (1.1kg)	155 (1.1kg)
23.0W	136 (0.9kg)	125 (0.9kg)
20.0W	136 (0.9kg)	125 (0.9kg)

