

Item no. DD138-5030MB9040D

Series Name: Cledy spark (Deep cone)
(DD138D)

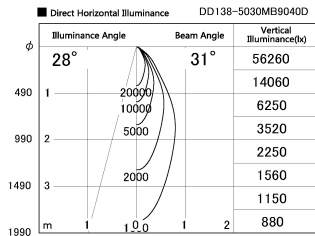

Installation	Recessed Mount	
Type	High-efficiency downlight Φ150	Fixed
Fixture wattage	48.5W	
Beam angle	31 deg	
Color Temp.	4000K	
CRI	Ra>90	
Luminous	6192 lm	
Body	Die-castaluminumalloy	
Body finish	Black	
Trim finish	Black	
Reflector finish	Mirror	
IP Rate	IP20	
Light source	COB module	
Input Voltage	AC220~240V	
Dimming Type	Non-Dimmable	
Certificate	CE,CCC	
Cut Hole	150	

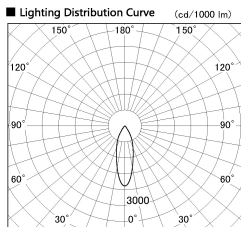
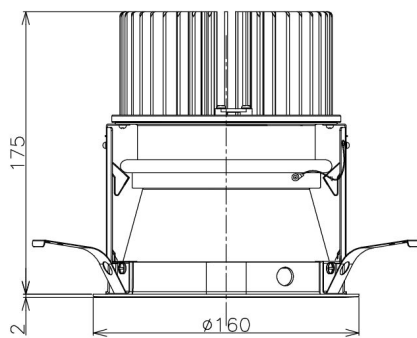

Height (Weight)	Spot / Medium / Medium flood	Wide flood
48.5W	175 (1.4kg)	
41.0W	155 (1.1kg)	
28.0W	166 (1.1kg)	155 (1.1kg)
23.0W	136 (0.9kg)	125 (0.9kg)
20.0W	136 (0.9kg)	125 (0.9kg)

