

Item no. DD187-0615W9035

Series Name: Cledy Micro (DD187)



Installation	Recessed mount
Type	Φ60 Pull out downlight
Fixture wattage	6W
Beam angle	13deg
Color Temp.	3500K
CRI	Ra>90
Luminous	413 lm
Body	Die-castaluminumalloy
Body finish	White
Trim finish	N/A
Reflector finish	N/A
IP Rate	IP20
Light source	COB module
Input Voltage	AC220~240V
Dimming Type	Non-Dimmable
Certificate	CE,CCC
Cut Hole	60mm

■ Lighting Distribution Curve (cd/1000 lm)

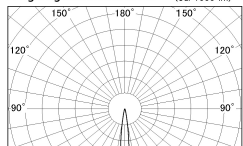

■ Direct Horizontal Illuminance DD187-0615W9035

φ	Illuminance Angle	Beam Angle	Vertical Illuminance(lx)
120	12°	13°	21150
100			5290
50			2350
20			1320
10			850

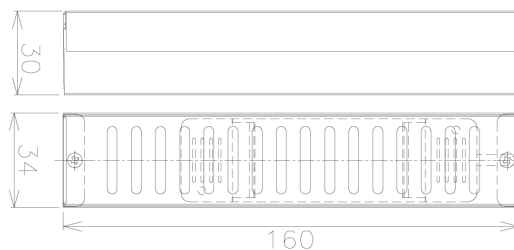
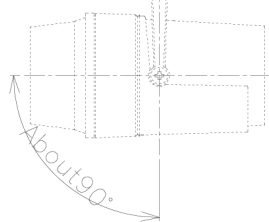
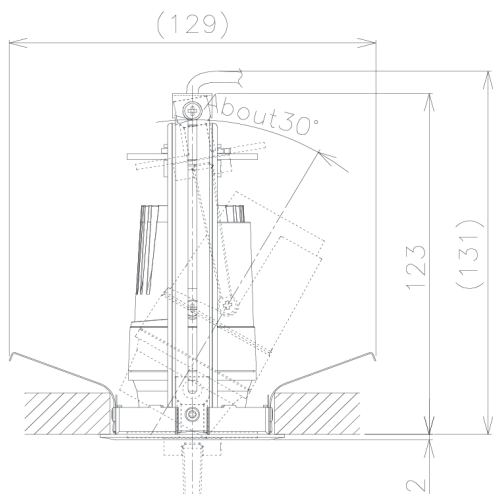

200±20

