

Item no. DD187-0625W9040

Series Name: Cledy Micro (DD187)



Installation	Recessed mount
Type	Φ60 Pull out downlight
Fixture wattage	6W
Beam angle	20deg
Color Temp.	4000K
CRI	Ra>90
Luminous	485 lm
Body	Die-castaluminumalloy
Body finish	White
Trim finish	N/A
Reflector finish	N/A
IP Rate	IP20
Light source	COB module
Input Voltage	AC220~240V
Dimming Type	Non-Dimmable
Certificate	CE,CCC
Cut Hole	60mm

■ Lighting Distribution Curve (cd/1000 lm)

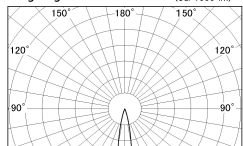

■ Direct Horizontal Illuminance DD187-0625W9040

φ	Illuminance Angle	Beam Angle	Vertical Illuminance(lx)
350	20°	20°	14060
1			3510
700			5000
			2000
			1560
			880
			560

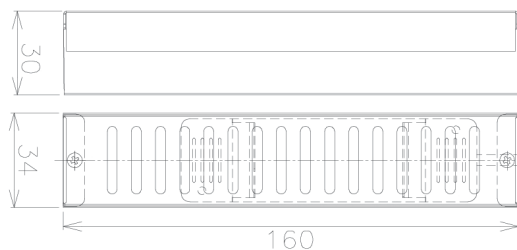
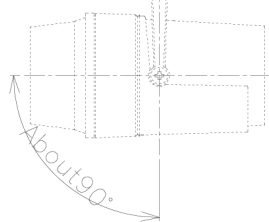
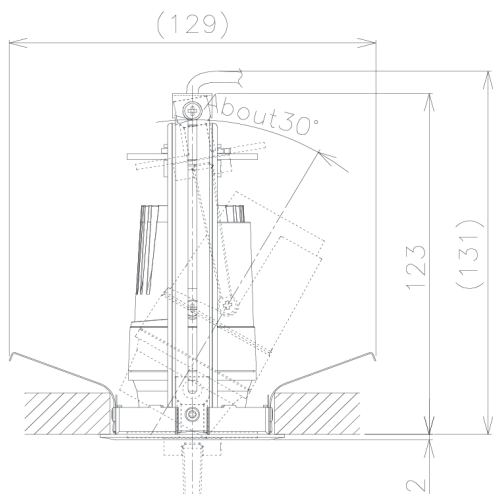

200±20

